

LOADING THE 50 BMG

1 REMOVE the reducer bushing to accept the Lee 1¼-12 thread 50 BMG dies (see FIGURE 7) Unscrew the shellholder insert using the primer arm as a lever, a large screwdriver or ¼ inch hex key wrench passed through the die opening of the press.



2 REPLACE the shellholder insert with the 50BMG shellholder. This can be threaded in by hand or with the aid of a pliers—turn until against the ram and unscrew to your desired position.



3 THE 50 BMG takes considerable force to size initially, especially if the cases are fired in a machine gun. Be sure to lubricate the cases with Lee Case Sizing Lube (FIGURE 8). Be generous with the lube. The vent hole in the die will prevent any lube dents. Other lubes, especially the spray lubes, do not provide sufficient lubrication and will likely cause the case to become stuck in your die or cause damage to your press lever.



4 CASES are primed with the Lee 50 BMG Ram Prime. Insert the priming post into the shellholder and install the shellholder body into the top of the press. Rotate the shellholder slot to most the most comfortable position. Primers should be seated flush to slightly below the the case head surface.

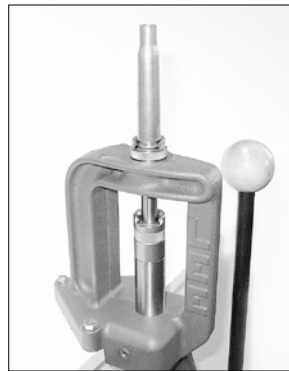
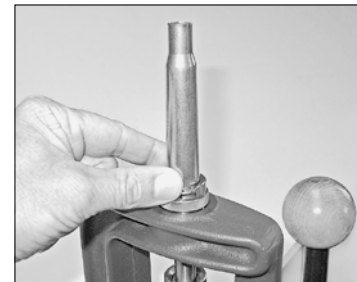

50 BMG Ram Prime Tool
Primes on the presses up stroke for best feel. Installs in seconds.



50 BMG Shellholder
Shellholder converts the Lee Classic Cast Press to load the 50 BMG. Fits only Lee Classic Cast Press.

LEE SAFETY PRIMER FEED 90997

THIS PRIMER FEED IS USABLE WITH ALL LEE PRESSES EQUIPPED WITH THE LEE LEVER PRIMER SYSTEM



1 INSTALL primer feed bracket with supplied 10-24 screws.



2 ROTATE shellholder insert so that primer arm is on right side of Classic Cast press.



3 INSTALL correct primer feed assembly; large white or small black trigger assembly into primer feed bracket



4 RAISE ram and swing primer feed into contact with the primer arm. If primer cup doesn't align with primer feeder, rotate arm forward or back until it does.



5 LOWER ram and remove primer feed. Remove primer tray from trough.



6 DEPRESS primer latch on tray, rotate counterclockwise and lift off cover. Place no more than 100 primers in tray; shake side to side to tip primers upright

7 SLIDE the trough and tray together, making sure that the trough is completely seated.

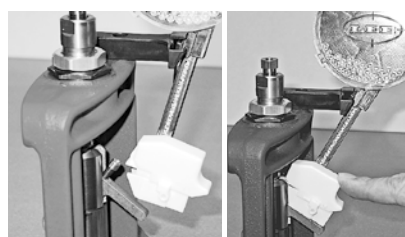

9 DE-PRIME and size a case. With ram at top of the stroke (handle down), push the trigger on primer feed to dispense a primer.

NOTE Trigger must be fully forward, then down to dispense a primer



10 LOWER ram (raise handle) to seat the primers. The primers should be flush to slightly below flush when properly seated.

8 RE-ATTACH primer feed into primer feed bracket

★ SMOOTH OPERATION TIP

Spent primers are extremely dirty, and after extended use it may be necessary to clean ram where primer lever is inserted. Clean the ram using gun scrubber, electrical contact cleaner or disc brake cleaner. Be sure to lubricate outside of ram with #30 weight motor oil or equivalent.

CHANGING primer sizes can be done in seconds!

- Replace L-shaped primer arm with the appropriate size
- Substitute appropriate feed assembly

90997 LARGE & SMALL KIT



Lee Safety Powder Scale 90681

It is the easiest to use, most accurate and sensitive powder scale made exclusively to weigh gun powder. The Lee Safety Scale has magnetic dampening and an approach to weight lifter enclosed within its heavy metal base. The exclusive safety beam has a stainless steel razor edge for maximum sensitivity. You can be sure that the Lee Safety Scale will retain its original factory accuracy for as long as it is not physically broken.

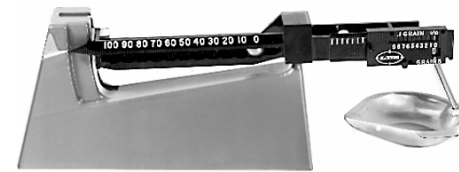

Lee Perfect Powder Measure 90058

This measure is unique because it solves all of the problems common to ordinary drum type measures. A soft elastomer wiper strikes off the metering chamber rather than cut the powder. The cone-shaped nylon drum can be adjusted to zero clearance. The metering rod is calibrated in cubic centimeters, the same units as our Auto Disk Powder measure and dippers. Capable of dispensing charges from 2 to 100 grains.



PARTS LIST

BP2770	Frame	BP2885	Pivot Pin Thru
BP3313	Pivot Pin Blind	BP3090	Lever
BP2780	Lever Sleeve	BP2774	Toggle Link
BP2888	Connecting Link	BP2921	Shellholder Insert
BP3000	Link Pin	BP3318	Instructions
BP3020	Ram	BP2889	*Primer Arm
BP3064	Clear PVC Tube	BP3088	5/16 Roll Pin
TR2447	Wood Knob	BP3136	1 x .103 O-Ring
BP2777	Lever Clamp	BP2979	Hex Bushing
FT3128	5/16 - 18 x 3 Bolt	FM1371	7/16 - 20 NF Nut
BP1427	Spacer	BP3127	Plastic Cap

*The primer arm comes as an assembly, including the primer pin, primer guide and return spring. Specify large or small when placing an order.

THE LEE GUARANTEE

LEE RELOADING PRODUCTS ARE GUARANTEED not to wear out or break from normal use for two full years, or they will be repaired or replaced at no charge if returned to the factory. Any Lee product of current manufacture—regardless of age or condition—will be reconditioned to new, including a new guarantee, if returned to the factory with payment equal to half the current retail price.

COMPLETE INSTRUCTIONS

LEE CLASSIC CAST

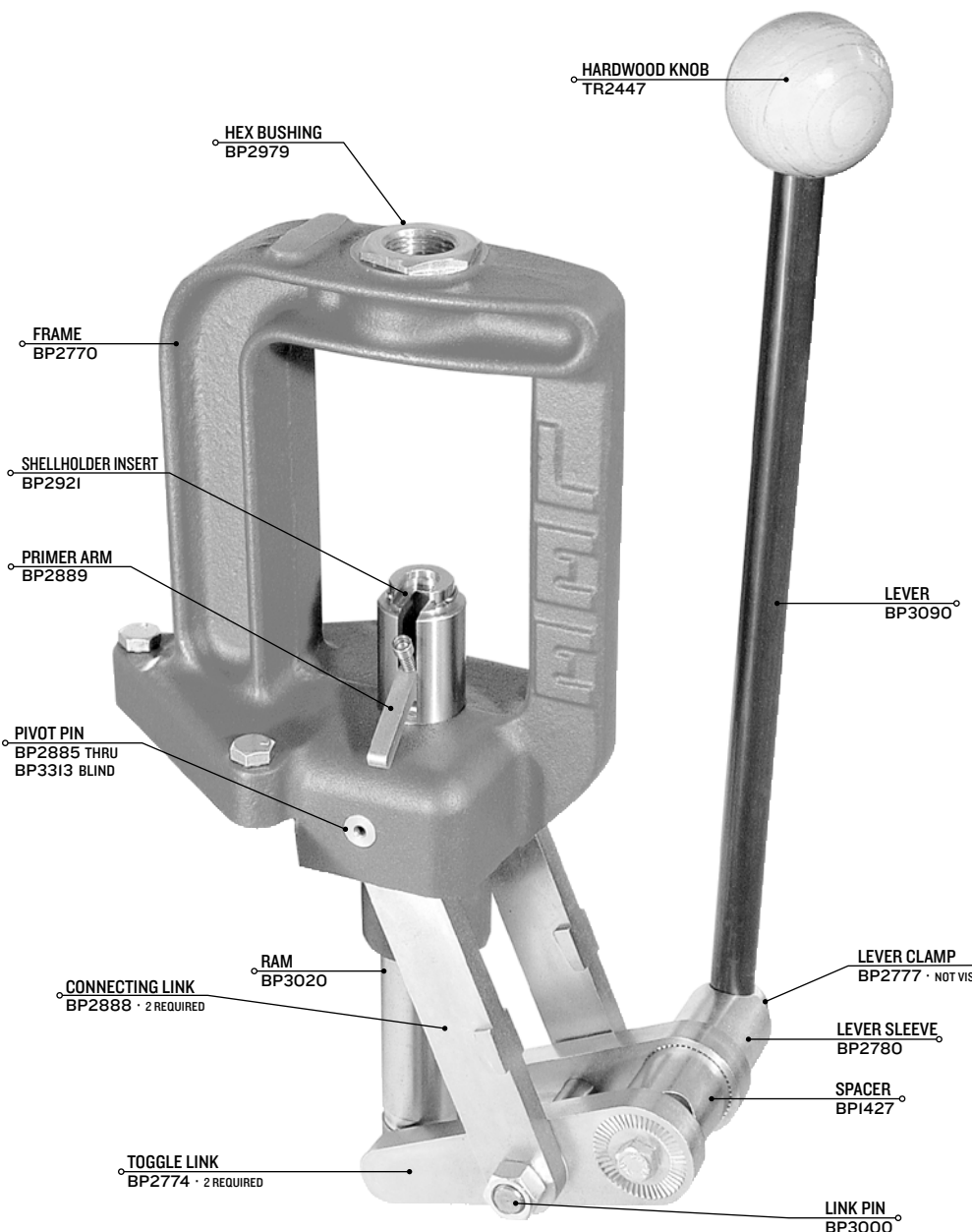

BP3318

CAUTION

Ammunition reloading can be dangerous if done improperly and should not be attempted by persons not willing and able to read and follow instructions exactly. Children should not be permitted to reload ammunition without strict parental supervision. Always wear safety glasses when reloading and shooting. Ammunition loaded with these tools and data should only be used in modern guns in good condition. We do not accept responsibility for ammunition loaded with these tools or data as we have no control over the manufacture and storage of components or the loading procedure and techniques. Primers and gun powders, like gasoline and matches, can be dangerous if improperly handled or misused.

LEE

LEE PRECISION, INC.

BEFORE YOU START RELOADING SETTING UP YOUR LEE CLASSIC CAST PRESS

Congratulations on your purchase of the Lee Classic Cast Press. We designed this press to be the finest and most convenient press made.

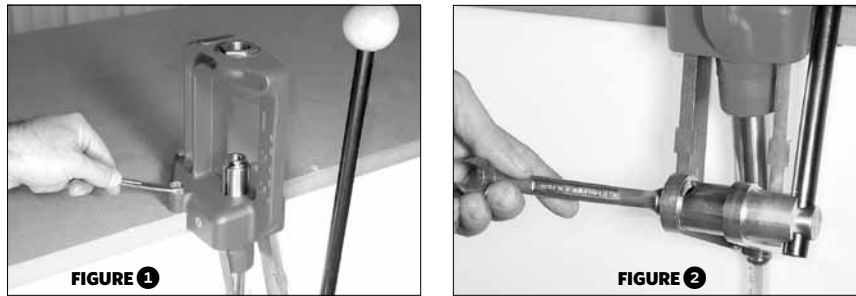

Attach the Classic Cast press to a sturdy bench with three $\frac{3}{4}$ or $\frac{9}{16}$ inch bolts (see FIGURE 1). This press has the same mounting bolt pattern as the Lee Turret Press, Pro 1000 and Loadmaster. Slide the press frame back onto the bench to where it stops against the vertical surfaces adjacent to the ram. When sliding the lever through the lever clamp, make sure the lever passes all the way through the lever sleeve (FIGURE 2). This will provide maximum leverage, and ensure even torque when the lever clamp bolt is tightened. With the lever in this position there is no under swing of the lever linkage, so the press can be mounted to any type of sturdy bench. Some operations benefit from a reduced lever throw (resizing/depriming pistol cases would be one example). This can be accomplished by loosening the lever clamp bolt and sliding the lever further through the clamp. To use this feature your bench should have at least 5 inches of clearance under the surface. Note that the lever can be installed on either side of the press for right or left handed operation. The lever angle is also adjustable by loosening the lever clamp bolt just enough to allow the teeth on the lever sleeve and toggle link to slip past one another. Lubricate the ram and all the pivot points on the press lever linkage. The ram and connecting link pivots can be lubricated through the pivot pins. Nearly any lightweight oil can be used; gun oil, sewing machine oil and motor oil are all acceptable. Avoid water displacing oils such as WD-40 and CRC56. Leave a film of oil on uncoated metal parts if the press is to be stored for over a week.

Slide the clear plastic PVC tube onto the hose barb built into the ram yoke (FIGURE 3). Spent primers pass through the hollow ram and are collected in the clear tube. This feature keeps the bearing surface of the ram free of the grit commonly found when depriming cases. Don't let the tube fill completely with primers. There is a cap on the end of the tube to allow for convenient disposal of spent primers, or the tube can be routed directly into a trashcan.

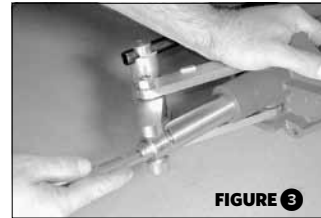

CROSS SECTION OF A TYPICAL CARTRIDGE

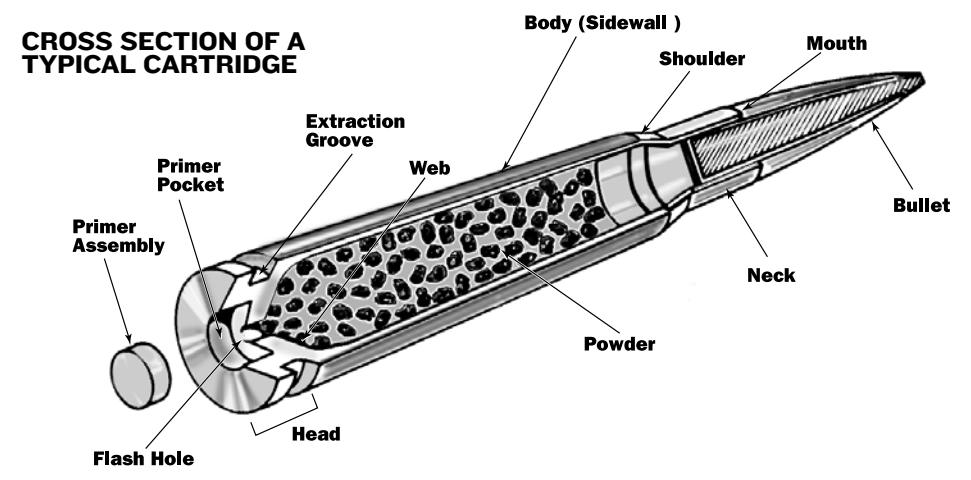

RELOADING IS QUITE A SIMPLE PROCESS

- Case is sized to original dimensions and the spent primer is removed
 - Install a new primer
 - Add a charge of powder
 - Seat a new bullet and crimp if desired
-

RELOADING SAFETY

Keep powder away from heat and open flames — Don't smoke

Store powder and primers in their original containers in a cool, dry place

Read and follow instructions exactly

Be sure you have the correct powder, measure and bullet of the correct weight

Any mixup can be dangerous

Exercise care and common sense at all times

WEAR SAFETY GLASSES WHEN RELOADING OR SHOOTING

IT IS YOUR RESPONSIBILITY TO ENSURE THE SAFETY OF YOUR LOADS

The following are factors that will increase pressures. Some will be dangerous.

- **DO NOT USE** more powder than recommended
- **DO NOT USE** a heavier bullet than recommended
- **DO NOT SEAT** the bullet deeper than normal
- **DO NOT USE** magnum primers unless using a slow burning ball powder
- **Greatly oversize bullets, excessively hard bullets or cases that are too long will cause higher pressures.**
- **High temperatures, or cartridges that were stored in a hot car or car trunk will produce higher pressures**

CASES

The easiest and best way of getting cases is to simply save those from your factory loaded rounds. New and used cases can also be purchased. Cases must be clean and safe. Do not use cases that have cracks or splits. If they have been used more than twice, they should be checked to see that none of them have become too long for safe use. The easiest way is to trim them is with a Lee Case Trimmer. This automatically cuts them to the correct length and no gauging or measuring is needed. After trimming, be sure to chamfer both the inside and outside of the case. A Lee Chamfer Tool works best, but it can be done with a pocket knife.

Straight sided cases, such as those used by most handguns, are loaded with a 3-die set.

MILITARY CASES

Used military cases are readily available at low cost. Usually, these have primers that are crimped in place. This is to prevent the primer from coming loose in automatic weapons and jamming the action at an inopportune time. The crimp must be removed before repriming. This can be done with a primer pocket reamer or swaging tool. Even a Lee Chamfer Tool can be used to ream the crimp.

POWDER

Powder is usually classified as smokeless and black powder. There is also Pyrodex, which is a substitute for black powder. We will be using only smokeless powder for reloading.

Each set of Lee Dies is supplied with powder measure and charge table with a generous selection of loads. Additional load data is available from all the powder manufacturers and bullet makers. This is excellent information and should be followed exactly.

Different powders are available to do different jobs. Bullets having a high sectional density (long length in relation to their diameter) require a slow burning powder. This permits sustained peak pressure to gain maximum acceleration within working pressure limits.

Short, light bullets use quicker burning powder for complete combustion within the barrel. A wide selection of powder is readily available.

Powders should always be stored in their original containers. While smokeless powder is not an explosive and not as dangerous to handle

as gasoline, it would be foolish to handle it carelessly and store excessive amounts. Follow the powder manufacturers' recommendations for storage and use.

PRIMERS

Rifle and pistol cartridges require different primers. Rifle primers have a thick and stronger cup to withstand the higher pressure. Pistol primers have a thinner cup for easy detonation with a lighter hammer blow. Both rifle and pistol primers are available in regular and magnum. Use regular for all loads except if the load data specifies magnum primers.

Primers must always be stored in their original containers. It is always a wise idea to wear safety or shooting glasses when shooting or reloading.

BULLETS

Commercial rifle bullets usually have a soft lead core with a copper jacket. Point shapes come in a variety of styles, but usually have some soft lead exposed to properly mushroom on impact.

The jackets serve a dual purpose: to control the bullet expansion and act as a bearing surface for its high speed travel down the bore. Some bullets have a crimping groove called a cannelure. This groove must be seated almost entirely in the case when crimping the case. The very end of the case mouth is turned into this groove by the bullet seating die used in a tubular magazine gun and most revolver ammunition.

Cast bullets are very popular with the handloader. They're very economical to use and for all guns where velocity is less than 2,000 feet per second can be as accurate as jacketed bullets. They do not normally expand as well as soft lead jacketed bullets on game. Therefore, it is poor economy to use them for hunting.

CRIMPING

Ammunition loaded for hunting should always have the bullets crimped in place, as should ammunition used in tubular magazine and auto-loading rifles. It could ruin your hunt if a bullet wedged in the chamber or pushed back into the case. Best accuracy is usually obtained with crimped ammo as the crimp has an effect on ignition, velocity, pressure and ballistic consistency. No die does a better job crimping than the patented Lee Factory Crimp Die.

YOU CAN NOW BEGIN RELOADING



1 INSTALL SHELLHOLDER

INSTALL SIZING DIE While holding the lever all the way down against its stop, turn the sizing die into the press until it touches the shellholder (figure 4). Raise the lever (lower the ram) and turn the die in an additional 1/4 to 1/2 turn. Lower the lever again, and use the ram to apply light pressure to the base of the die. This will keep the die from turning as one tightens the lock ring to secure the adjustment just made.

PREPARE YOUR CASES If you are using a steel sizing die, it is necessary to lubricate your cases. This is also a good time to inspect cases for split necks, indications of head separation or other defects. Apply a thin film of Lee Case Resizing Lubricant (CATALOG #90006) with your fingers. This method will allow you to detect any grit that may be clinging to case, which would scratch the sizing die if not removed. The case may be sized immediately or allowed to dry.

RESIZE THE CASE Place the cartridge case in the shellholder and raise the ram until the shellholder contacts the base of the die. It is important to verify that the shellholder contacts the base of the sizing die when resizing the cartridge case. This establishes correct headspace.

PRIMING The Classic Cast Press includes two primer arms, one each for large and small primers. To set your press up for priming, turn the shellholder insert all the way into the ram, and then back it out so the slot faces away from the press lever, so you can operate the lever with one hand and insert primers with the other (FIGURE 5). Raise the ram about 3 inches, so the entire shellholder insert can be seen above the base of the press. Insert the primer arm so that the notch in the bottom of the primer arm engages with the cross pin in the shellholder insert. To complete set up install the appropriate shellholder. Cycle the press lever a few times to familiarize yourself with the priming mechanism. As you lift the lever all the way up, the primer arm tips vertical and aligns with the hole in the center of the shellholder. As the lever is lowered, the primer arm drops down and tips back out to allow easy insertion of another primer (FIGURE 6). When you are ready to begin priming, approach the end of the stroke slowly so you can feel the slight increase in resistance as the primer is pressed into the case. Lift hard enough on the lever to seat the primer flush.

The optional primer feed is mounted to the flat surface on top of the press. Note that with the primer feed installed, the shellholder adapter must be turned so the primer arm faces to the right. Turn the shellholder adapter all the way into the ram first, and then back it out so the primer lever faces to the right.

FINAL CHECK Check your reloaded cartridges for any signs of defects. If there is any doubt about the quality or correctness of a reloaded cartridge, dispose of it properly. Do not take an unnecessary chance on questionable ammunition. If loading maximum loads, it is good practice to remove all traces of case lubricant with detergent and water. This will reduce pressure against the bolt.

ADDITIONAL FEATURES There is a reducer-bushing factory installed in the Classic Cast press. Removal of this bushing allows the use of 1 1/4-12 dies. You will need a 1 1/8 inch socket or large adjustable wrench to remove the reducer bushing (FIGURE 7).

LEAD WARNING
Primers contain lead; a substance known to cause birth defects, reproductive harm and other serious physical injury. Wash hands after exposure.

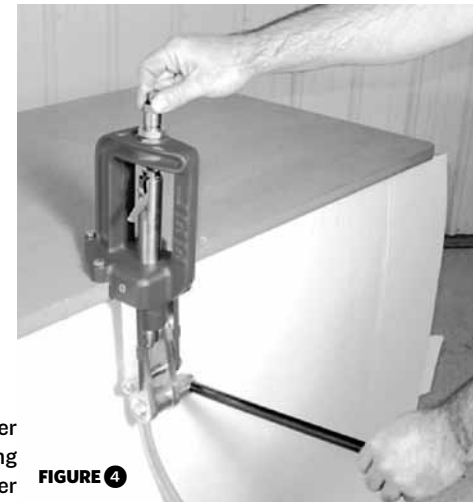

FIGURE 4



FIGURE 5

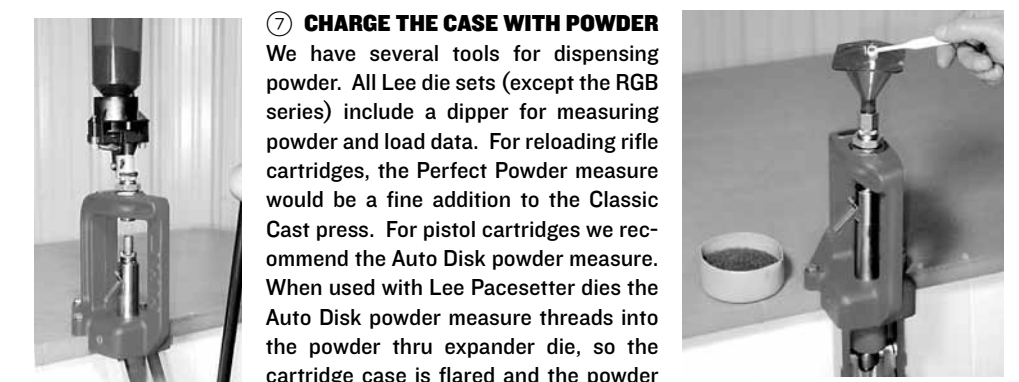

FIGURE 6



FIGURE 7

FLARING THE CASE MOUTH Most pistol cartridges should have the case mouth flared before seating the bullet. This allows even soft cast lead bullets to be pressed into the cartridge case without damage to the bullet base or bearing surface. This step is omitted in most rifle cartridges. Lee pistol die sets contain a Powder Thru Expander die, which allows you to charge the case with powder and flare the case mouth at the same time. To set up the Powder Thru Expander die, place a sized, empty case in the shellholder and raise the ram to the top of its stroke. Maintain light pressure on the lever, and turn the Powder Thru die into the press until you feel resistance. It is important that either the funnel adapter or the Auto Disk powder measure is installed in the Powder Thru die for this step. Lower the ram and turn the die in one full turn. Raise the ram to the top of its stroke again, then withdraw the case and place a bullet on top of the case mouth. If the base of the bullet does not fit into the case, turn the Powder Thru die in one half turn and press the case back into the die. Repeat the above process until you are satisfied with the amount of flare on the case mouth.



CHARGE THE CASE WITH POWDER We have several tools for dispensing powder. All Lee die sets (except the RGB series) include a dipper for measuring powder and load data. For reloading rifle cartridges, the Perfect Powder measure would be a fine addition to the Classic Cast press. For pistol cartridges we recommend the Auto Disk powder measure. When used with Lee Pacesetter dies the Auto Disk powder measure threads into the powder thru expander die, so the cartridge case is flared and the powder charge is added simultaneously. Regardless of how you charge the case, be absolutely certain that you have the correct type and amount of powder for the bullet you have selected.

NEVER try to seat the primer deeper after the powder has been added.

BULLET SEATING Place a bullet on the case mouth and guide it into the die. Raise the ram to the top and withdraw. The knurled adjusting screw controls the bullet seating depth. Adjust to suit. Usually, seating to the same depth as a factory round works fine. If you desire to crimp, be sure the bullet crimp groove is almost completely inside the case. Then screw the die body in just enough to apply a good crimp. Attempts to apply excessive crimp will crush the case. For proper crimp all cases must be trimmed to the same length. For best utility and accuracy, consider the Lee Factory Crimp Die. You will never crush a case; no crimp groove is required and trim length is not critical.

FINAL CHECK Check your reloaded cartridges for any signs of defects. If there is any doubt about the quality or correctness of a reloaded cartridge, dispose of it properly. Do not take an unnecessary chance on questionable ammunition. If loading maximum loads, it is good practice to remove all traces of case lubricant with detergent and water. This will reduce pressure against the bolt.

ADDITIONAL FEATURES There is a reducer-bushing factory installed in the Classic Cast press. Removal of this bushing allows the use of 1 1/4-12 dies. You will need a 1 1/8 inch socket or large adjustable wrench to remove the reducer bushing (FIGURE 7).

LEAD WARNING
Primers contain lead; a substance known to cause birth defects, reproductive harm and other serious physical injury. Wash hands after exposure.